

GROUP BSC INTERNATIONAL



Focus on solar lighting



CONTENTS



01 BS-GLJ003 ^{New} 	03 BS-GLL 	05 BS-GLF001 ^{New} 
07 BS-GLB80 	09 BS-GLG001 	11 BS-GGD4205 ^{New} 
13 BS-GLJ160/200 	15 BS-GGD0203 ^{New} 	17 BS-GLJ 
19 BF-GLK 	21 BS-STD 	23 BS-STE 
25 BS-TED01 	27 BS-TGD02 	29 BS-CPD0406 ^{New} 
31 BS-CPD2104 ^{New} 	33 BS-GLG45/70 	35 BS-GLJ50/75/100 
37 BS-GLE40/60/80 	39 BS-GLA30/60/80 	41 BS-GLH35/65/85 
43 ZC-CPD2204 	45 ZC-CPD2106 	47 BS-GLD70 
49 BS-BD2104 ^{New} 	51 BS-WLI001 	53 BS-WLH001 

55 BS-WLG001 	57 BS-WLD001 	59 BS-WLE001 
61 BS-WLF001 	63 BS-WLA001 	65 BS-WLC001 
67 BS-ZTD0406 ^{New} 	69 BS-ZTD4205 ^{New} 	71 BS-ZTD2104 ^{New} 
73 BS-GLJ25 	75 BS-GLG30 	77 BS-GLK37 
79 BS-GLH25 	81 BS-GLI25 	83 BS-GLR 
85 BS-ZTD5512 	87 BS-GLN 	89 BS-ZTD3604 
89 BS-GLT 	91 BS-STF 	93 BS-STC 
95 BS_STH 	97 BS-STB 	99 BS-STA 
101 BS-FLBL 	103 BS-FLA 	105 BS-XDD2010 ^{New} 



Φ530mm

490mm

3000/4000mm

PRODUCT PARAMETERS

Model	BS-GLJ003
Solar panels	5V/25W
Battery	3.2V/30Ah
Colour temperature	3000/6500K
Charge time	3-5H
Water proof grade	IP65
Material quality	AL+PC
Size	Φ530*H490mm

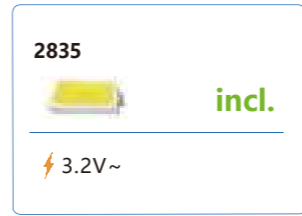
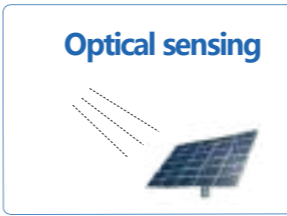

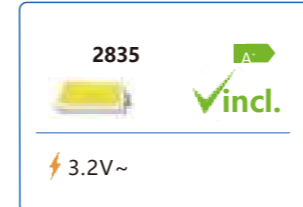
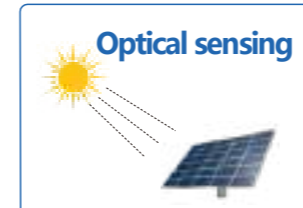

PRODUCT PARAMETERS

Model	BS-GLL-D200	BS-GLL-T300	BS-GLL-Q300
Solar panels	5V/21W	5V/28W	5V/35W
Battery	3.2V/20Ah	3.2V/30Ah	3.2V/40Ah
Colour temperature	3000/6500K	3000/6500K	3000/6500K
Charge time	3-5H	3-5H	3-5H
Water proof grade	IP65	IP65	IP65
Material quality	AL+PC	AL+PC	AL+PC
Size	Φ1070*H3000mm	Φ960*H3000mm	Φ1070*H3000mm



ZL 2017 3 0673378.2

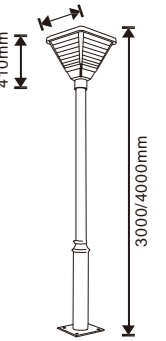

PRODUCT PARAMETERS

Model	BS-GLF001
Solar panels	5V/20W
Battery	3.2V/20Ah
Colour temperature	3000/6500K
Charge time	3-5H
Water proof grade	IP65
Material quality	AL+PC
Size	400*400*H410mm

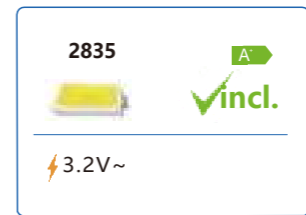
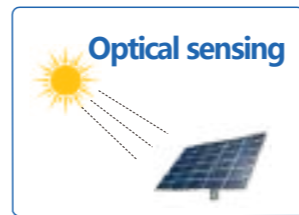

ZL 2019 3 0009083.4

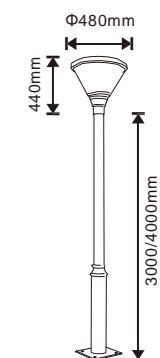

PRODUCT PARAMETERS

Model	BS-GLB80
Solar panels	5V/20W
Battery	3.2V/20Ah
Colour temperature	3000/6500K
Charge time	3-5H
Water proof grade	IP65
Material quality	AL+PC
Size	Φ480*H440mm

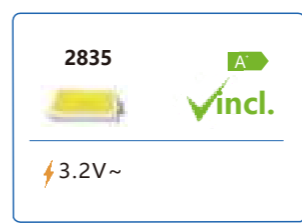
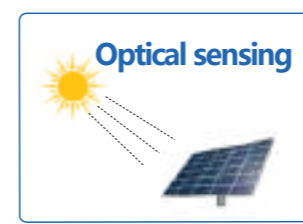

: ZL 2019 3 0446856.5

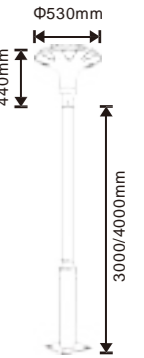

PRODUCT PARAMETERS

Model	BS-GLG001
Solar panels	5V/25W
Battery	3.2V/30Ah
Colour temperature	3000/6500K
Charge time	3-5H
Water proof grade	IP65
Material quality	AL+PC
Size	Φ530*H440mm

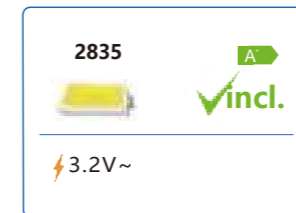
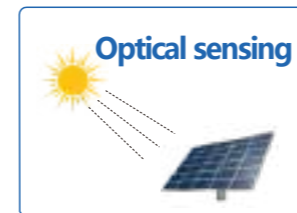

: ZL 2018 3 0571592.1



New



PRODUCT PARAMETERS

Model	BS-GGD4205
Solar panels	5V/10W
Battery	3.2V/12000mAh
Colour temperature	3000/6500K
Charge time	3-5H
Water proof grade	IP65
Material quality	+PC 300*300*H1000-
Size	2600mm

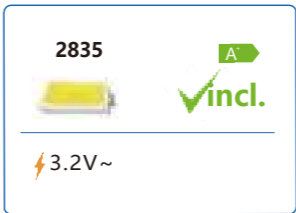
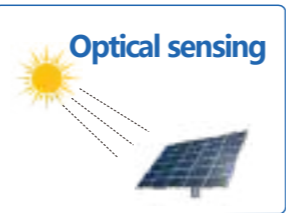

: 2020 3018 8325 3

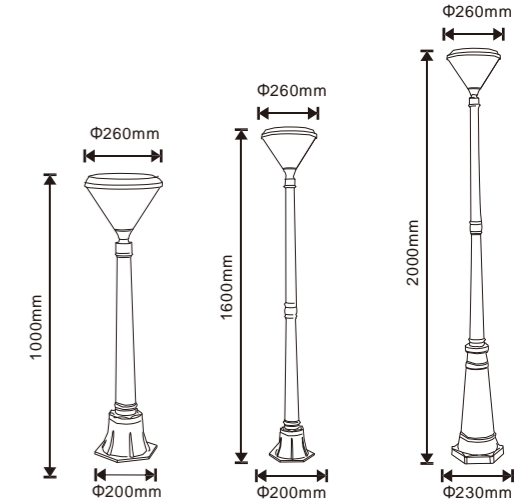

PRODUCT PARAMETERS

Model	BS-GLJ200
Solar panels	5V/4.5W
Battery	3.2V/7Ah
Colour temperature	3000/6500K
Charge time	3-5H
Water proof grade	IP65
Material quality	AL+PC
Size	Φ260*H1000/2000mm

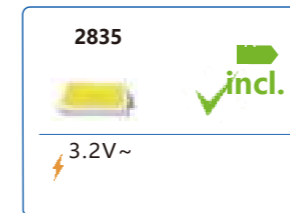
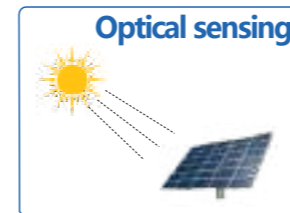

: ZL 2018 3 0773432.5



New

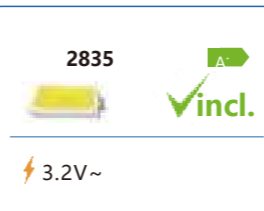
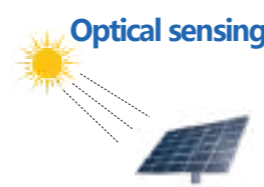
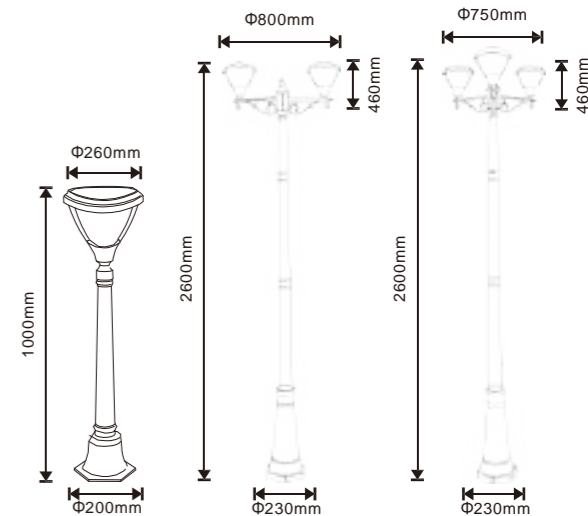

PRODUCT PARAMETERS

Model	BS-GGD0203-1	BS-GGD0203-2	BS-GGD0203-3
Solar panels	5V/4.5W	5V/4.5W*2	5V/4.5W*3
Battery	3.2V/7000mAh	3.2V/14000mAh	3.2V/21000mAh
Colour temperature	3000/6500K	3000/6500K	3000/6500K
Charge time	3-5H	3-5H	3-5H
Water proof grade	IP65	IP65	IP65
Material quality	+PC	+PC	+PC
Size	Φ260*H1000mm	Φ800*H2600mm	Φ750*H2600mm



: 2020 3018 8345 0

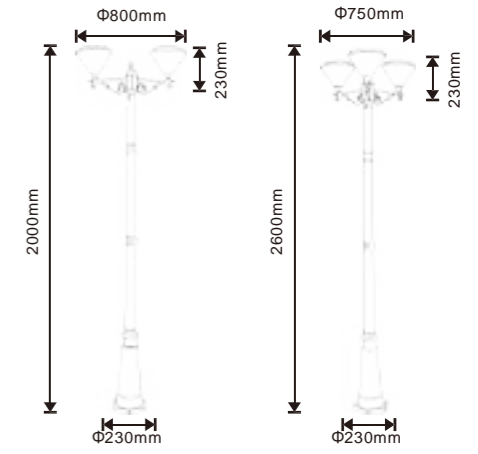

PRODUCT PARAMETERS

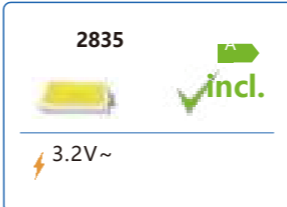
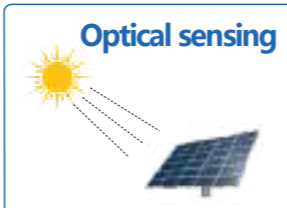

Model	BS-GLJD260-2	BS_GLJT260-3
Solar panels	5V/4.5W*2	5V/4.5W*3
Battery Colour	3.2V/14Ah	3.2V/21Ah
temperature	3000/6500K	3000/6500K
Charge time	3-5H	3-5H
Water proof grade	IP65	IP65
Material quality	AL+PC	AL+PC
Size	800*230*H2000mm	750*230*H2600mm



: ZL 2018 3 0773432.5

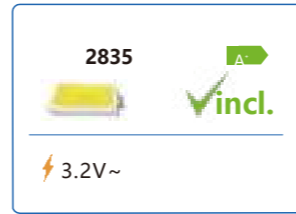
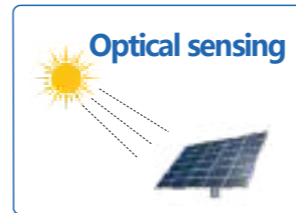

PRODUCT PARAMETERS

Model	BS-GLK100-1	BS-GLKD260-2	BS-GLKT260-3
Solar panels	5V/4.5W	5V/4.5W*2	5V/4.5W*3
Battery	3.2V/7Ah	3.2V/14Ah	3.2V/21Ah
Colour temperature	3000/6500K	3000/6500K	3000/6500K
Charge time	3-5H	3-5H	3-5H
Water proof grade	IP65	IP65	IP65
Material quality	AL+PC	AL+PC	AL+PC
Size	Φ260*H1000mm	Φ260*H2600mm	Φ260*H2600mm



: ZL 2019 3 0009097.6

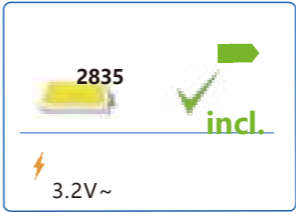
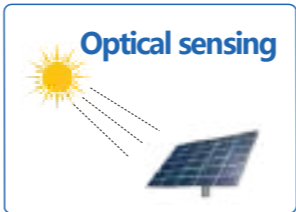
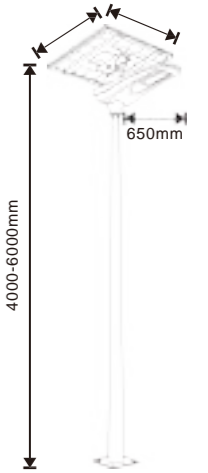

PRODUCT PARAMETERS

Model	BS_STD50	BS_STD100
Solar panels	5V/40W	5V/50W
Battery	3.2V/30Ah	3.2V/40Ah
Colour temperature	3000/6500K	3000/6500K
Charge time	3-5H	3-5H
Water proof grade	IP65	IP65
Material quality	AL	AL
Size	650*260*370mm	650*260*370mm



: ZL 2018 3 0293024.X

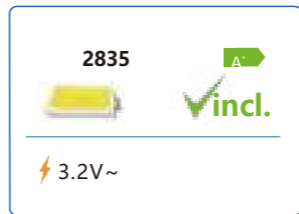
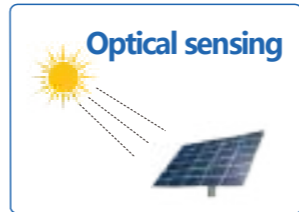
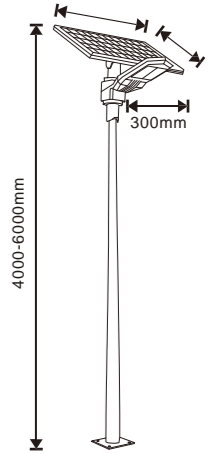

PRODUCT PARAMETERS

Model	BS-STE50	BS-STE100	BS-STE150
Solar panels	5V/40W	5V/50W	5V/60W
Battery	3.2V/20Ah	3.2V/40Ah	3.2V/60Ah
Colour temperature	3000/6500K	3000/6500K	3000/6500K
Charge time	3-5H	3-5H	3-5H
Water proof grade	IP65	IP65	IP65
Material quality	AL	AL	AL
Size	610*200*390mm	610*200*390mm	610*200*390mm



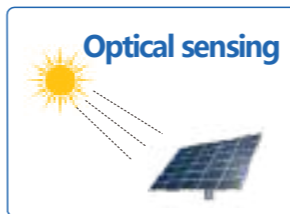
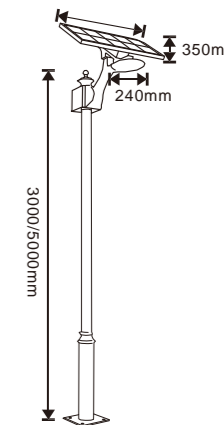

PRODUCT PARAMETERS

Model	BS-TED0112	BS-TED0118	BS-TED0124
Solar panels	5V/25W	5V/35W	5V/40W
Battery	3.2V/20000mAh	3.2V/25000mAh	3.2V/30000mAh
Colour temperature	3000-6500K	3000-6500K	3000-6500K
Charge time	3-5H	3-5H	3-5H
Water proof grade	IP65	IP65	IP65
Material quality	AL	AL	AL
Size	590*160*390mm	590*160*390mm	590*160*390mm



: ZL 2016 2 1166474.4

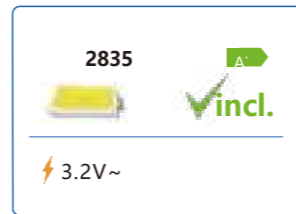
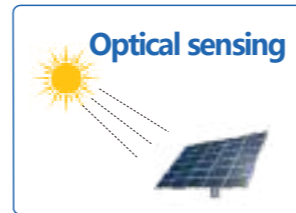
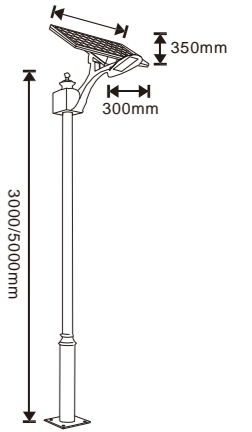

PRODUCT PARAMETERS

Model	BS-TGD0215	BS-TGD0224	BS-TGD0230
Solar panels	5V/25W	5V/35W	5V/30W
Battery Colour	3.2V/20000mAh	3.2V/25000mAh	3.2V/30000mAh
temperature	3000-6500K	3000-6500K	3000-6500K
Charge time	3-5H	3-5H	3-5H
Water proof grade	IP65	IP65	IP65
Material quality	AL	AL	AL
Size	680*160*390mm	680*160*390mm	680*160*390mm



: ZL 2016 2 1166474.4



New

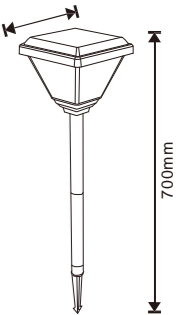

PRODUCT PARAMETERS

Model	BS-CPD0406
Solar panels	5V/2W
Battery	3.2V/1500mAh
Colour temperature	3000/6500K
Charge time	3-5H
Water proof grade	IP65
Material quality	ABS+PC
Size	160*160*H700mm

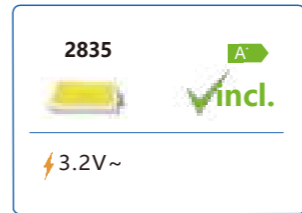
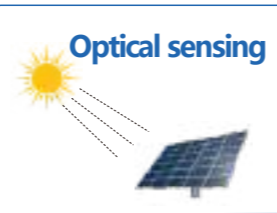

: 202030188345.0



New

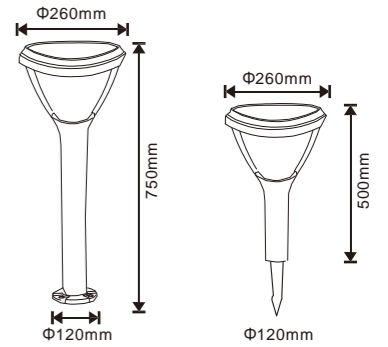

PRODUCT PARAMETERS

Model	BS-CPD2104
Solar panels	5V/4.5W
Battery	3.2V/7000mAh
Colour temperature	3000/6500K
Charge time	3-5H
Water proof	IP65
Grade	+PC Φ260*H750/500mm

Material quality Size

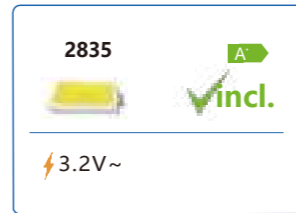
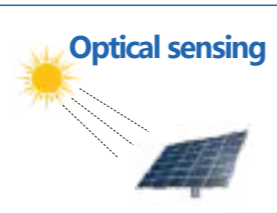

: 202030188345.0



PRODUCT PARAMETERS

Model	BS-GLG45/75
Solar panels	5V/4.5W
Battery	3.2V/7Ah
Colour temperature	3000/6500K
Charge time	3-5H
Water proof grade	IP65
Material quality	AL+PC
Size	Φ260*H450/700mm

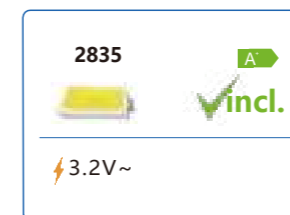
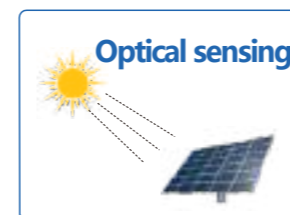

: ZL 2018 3 0571592.1

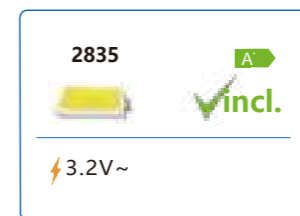
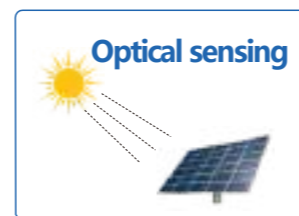
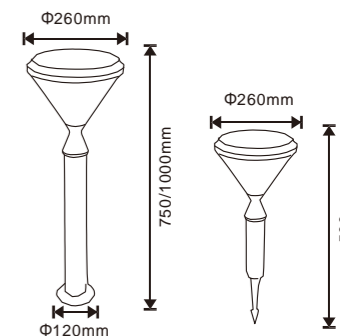

PRODUCT PARAMETERS

Model	BS-GLJ50/75/100
Solar panels	5V/4.5W
Battery	3.2V/7Ah
Colour temperature	3000/6500K
Charge time	3-5H
Water proof grade	IP65
Material quality	AL+PC
Size	Φ260*H500/750/1000mm



: ZL 2018 3 0129979.1

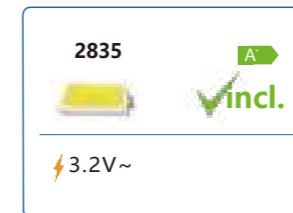
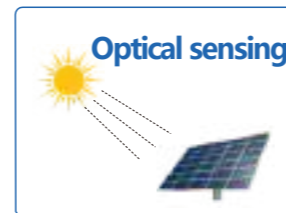
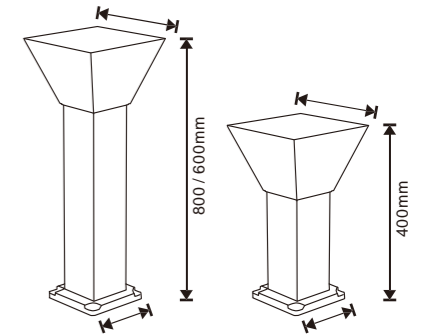

PRODUCT PARAMETERS

Model	BS-GLE40/60/80
Solar panels	5V/5W
Battery	3.2V/6Ah
Colour temperature	3000/6500K
Charge time	3-5H
Water proof grade	IP65
Material quality	AL+PC
Size	260*H400/600/800mm



: ZL 2017 3 0673465.8

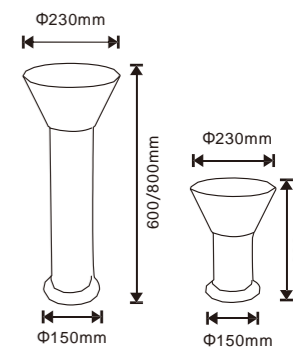

PRODUCT PARAMETERS

Model	BS-GLA30/60/80
Solar panels	5V/4.5W
Battery	3.2V/6Ah
Colour temperature	3000/6500K
Charge time	3-5H
Water proof grade	IP65
Material quality	AL+PC
Size	Φ230*H300/600/800mm

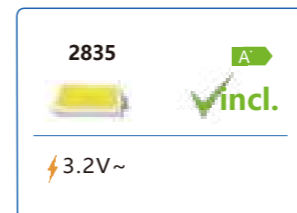
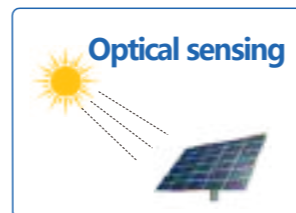

: ZL 2017 3 0437661.5

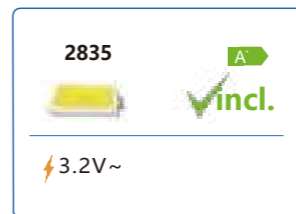
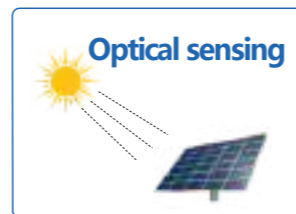
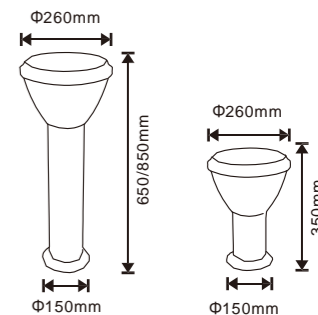

PRODUCT PARAMETERS

Model	BS-GLH35/65/85
Solar panels	5V/4.5W
Battery	3.2V/7Ah
Colour temperature	3000/6500K
Charge time	3-5H
Water proof grade	IP65
Material quality	AL+PC
Size	Φ260*H350/650/850mm



: ZL 2018 3 02844826.4

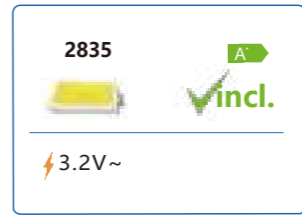
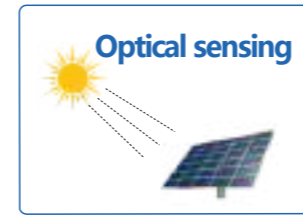
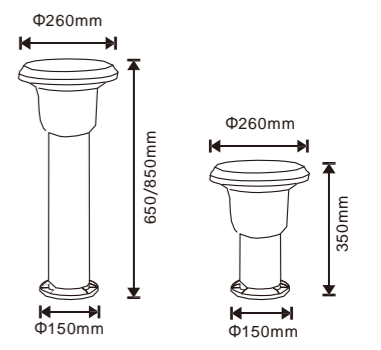

PRODUCT PARAMETERS

Model	BS-GLI35/65/85
Solar panels	5V/4.5W
Battery	3.2V/7Ah
Colour temperature	3000/6500K
Charge time	3-5H
Water proof grade	IP65
Material quality	AL+PC
Size	Φ260*H350/650/850mm



: ZL 2018 3 0516647.9

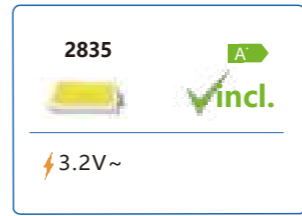
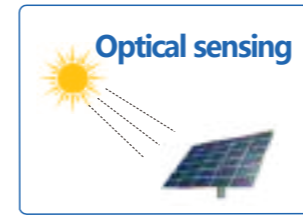
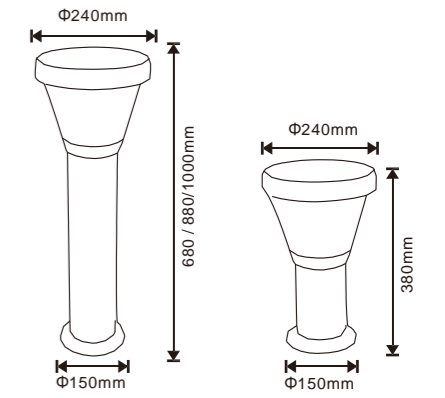

PRODUCT PARAMETERS

Model	BS-GLK38/68/88/100
Solar panels	5V/4.5W
Battery	3.2V/7Ah
Colour temperature	3000/6500K
Charge time	3-5H
Water proof grade	IP65
Material quality	AL+PC
Size	Φ260*H380/680/880mm

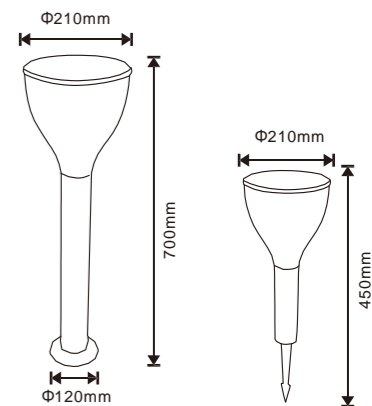

PRODUCT PARAMETERS

Model	BS-GLC45/700
Solar panels	6V/3W
Battery	3.7V/4.4Ah
Colour temperature	3000/6500K
Charge time	3-5H
Water proof grade	IP65
Material quality	AL+PC
Size	$\Phi 210 \times H 450/700\text{mm}$

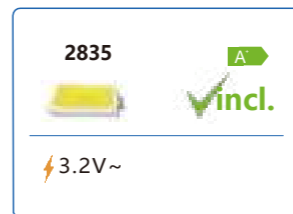
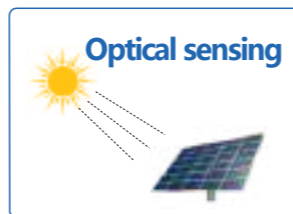

: ZL 2017 3 0544249.3



New

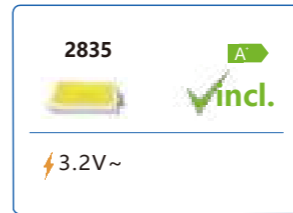
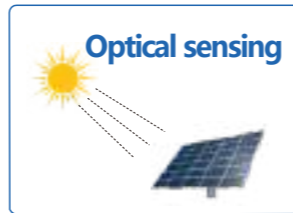
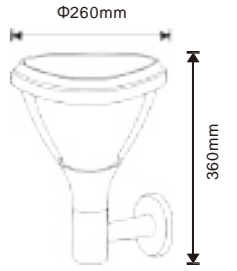

PRODUCT PARAMETERS

Model	BS-BD2104
Solar panels	5V/4.5W
Battery	3.2V/7000mAh
Colour temperature	3000-6500K
Charge time	3-5H
Water proof grade	IP65
Material quality	+PC Φ260*H360mm

Size



: 202030188345.0

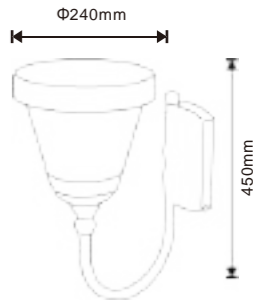

PRODUCT PARAMETERS

Model	BS-WLI001
Solar panels	5V/4.5W
Battery	3.2V/7Ah
Colour temperature	3000/6500K
Charge time	3-5H
Water proof grade	IP65
Material quality	AL+PC
Size	Φ240*H450mm

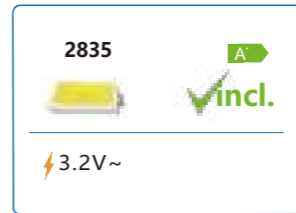
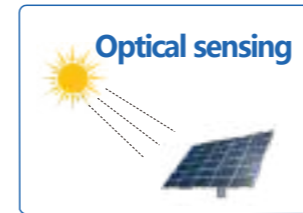

: ZL 2019 3 0009097.6

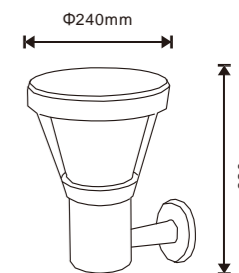

PRODUCT PARAMETERS

Model	BS-WLH001
Solar panels	5V/4.5W
Battery	3.2V/7Ah
Colour temperature	3000/6500K
Charge time	3-5H
Water proof grade	IP65
Material quality	AL+PC
Size	Φ240*H320mm

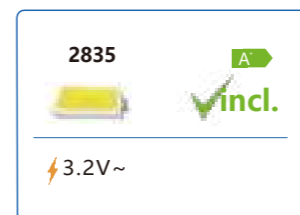
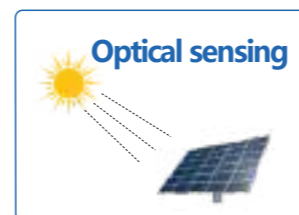

: ZL 2019 3 0009097.6

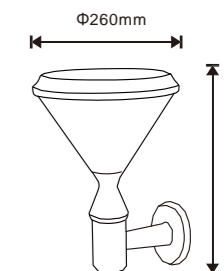

PRODUCT PARAMETERS

Model	BS-WLG001
Solar panels	5V/4.5W
Battery	3.2V/7Ah
Colour temperature	3000/6500K
Charge time	3-5H
Water proof grade	IP65
Material quality	AL+PC
Size	Φ260*H370mm

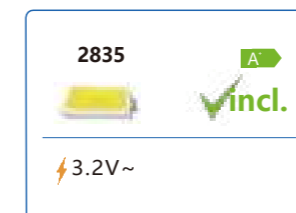
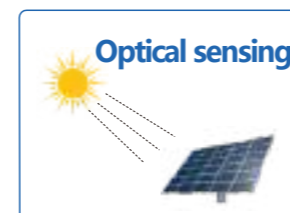

: ZL 2018 3 0129979.1

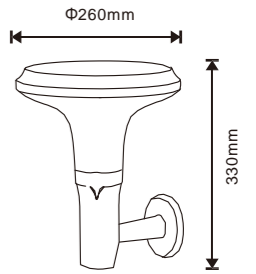

PRODUCT PARAMETERS

Model	BS-WLD001
Solar panels	5V/4.5W
Battery	3.2V/7Ah
Colour temperature	3000/6500K
Charge time	3-5H
Water proof grade	IP65
Material quality	AL+PC
Size	Φ260*H330mm

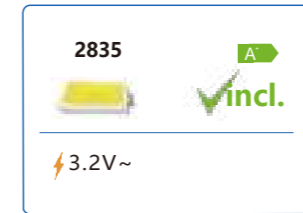
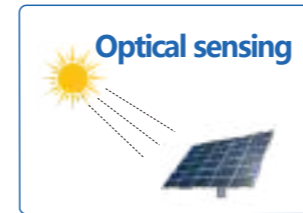

: ZL 2018 3 0571592.1

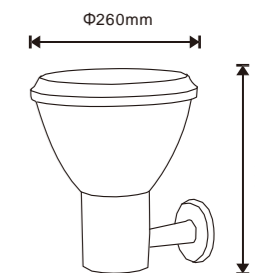

PRODUCT PARAMETERS

Model	BS-WLE001
Solar panels	5V/4.5W
Battery	3.2V/7Ah
Colour temperature	3000/6500K
Charge time	3-5H
Water proof grade	IP65
Material quality	AL+PC
Size	Φ260*H310mm

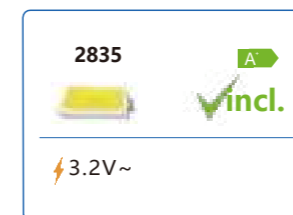
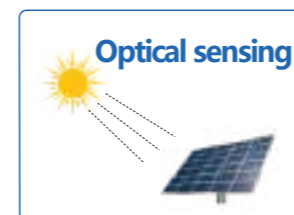

: ZL 2018 3 0284826.4

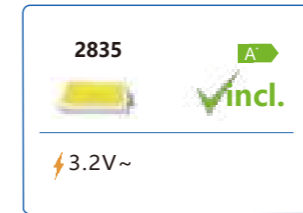
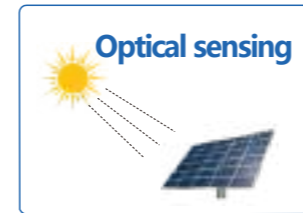

PRODUCT PARAMETERS

Model	BS-WLF001
Solar panels	5V/4.5W
Battery	3.2V/7Ah
Colour temperature	3000/6500K
Charge time	3-5H
Water proof grade	IP65
Material quality	AL+PC
Size	Φ260*H300mm



: ZL 2018 3 0516647.9

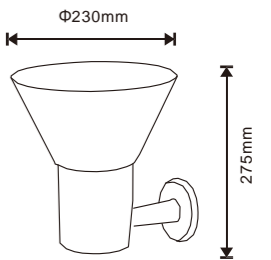

PRODUCT PARAMETERS

Model	BS-WLA001
Solar panels	5V/4.5W
Battery	3.2V/6Ah
Colour temperature	3000/6500K
Charge time	3-5H
Water proof grade	IP65
Material quality	AL+PC
Size	Φ230*H275mm

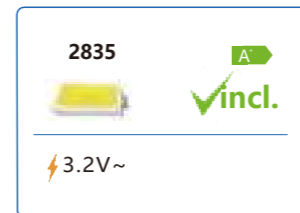
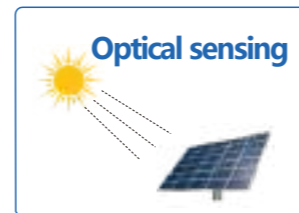

: ZL 2017 3 0437661.5

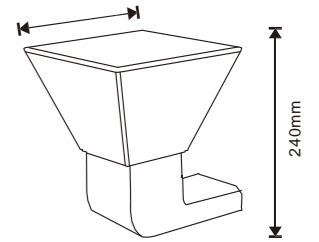

PRODUCT PARAMETERS

Model	BS-WLC001
Solar panels	5V/5W
Battery	3.2V/6Ah
Colour temperature	3000/6500K
Charge time	3-5H
Water proof grade	IP65
Material quality	AL+PC
Size	200*H240mm

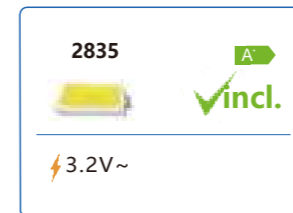
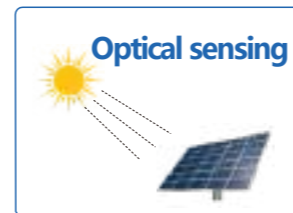

: ZL 2017 3 0673465.8



New

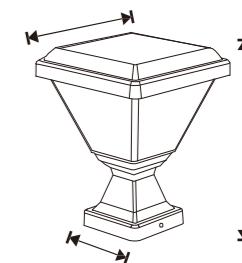

PRODUCT PARAMETERS

Model	BS-ZTD0406
Solar panels	5V/2W
Battery	3.2V/1500mAh
Colour temperature	3000/6500K
Charge time	3-5H
Water proof grade	IP65
Material quality	ABS+PC
Size	160*160*H200mm

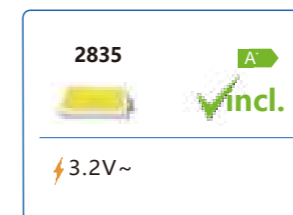
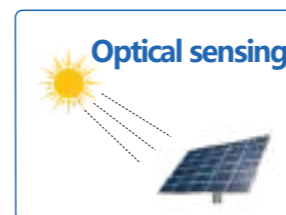

: 202030188345.0



New

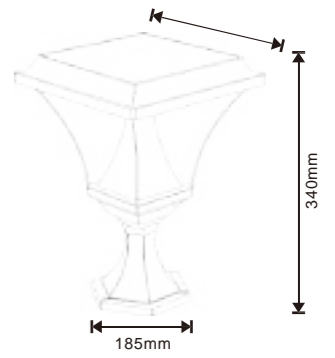

PRODUCT PARAMETERS

Model	BS-ZTD4205
Solar panels	5V/10W
Battery	3.2V/12000mAh
Colour temperature	3000/6500K
Charge time	3-5H
Water proof grade	IP65
Material quality	+PC
Size	300*300*H340mm

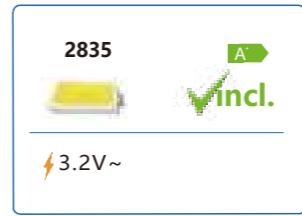
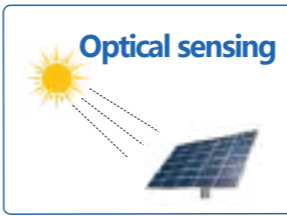

: 2020 3018 8325 3



New

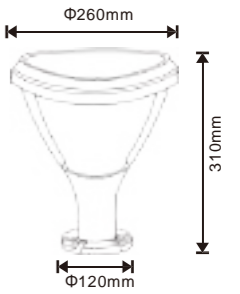
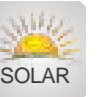

PRODUCT PARAMETERS

Model	BS-ZTD2104
Solar panels	5V/4.5W
Battery	3.2V/7000mAh
Colour temperature	3000/6500K
Charge time	3-5H
Water proof grade	IP65
Material quality	+PC Φ260*H310mm

Size

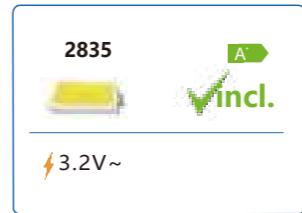
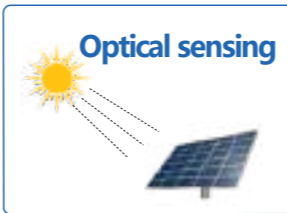

: 202030188345.0

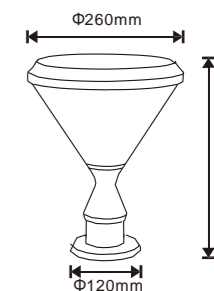

PRODUCT PARAMETERS

Model	BS-GLJ25
Solar panels	5V/4.5W
Battery	3.2V/7Ah
Colour temperature	3000/6500K
Charge time	3-5H
Water proof grade	IP65
Material quality	AL+PC
Size	Φ260*H300mm

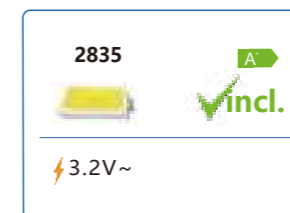
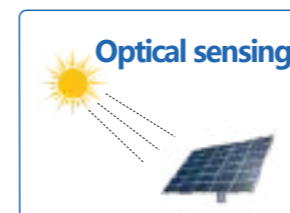

: ZL 2018 3 0129979.1

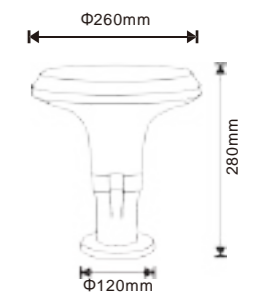

PRODUCT PARAMETERS

Model	BS-GLG30
Solar panels	5V/4.5W
Battery	3.2V/7Ah
Colour temperature	3000/6500K
Charge time	3-5H
Water proof grade	IP65
Material quality	AL+PC
Size	Φ260*H280mm

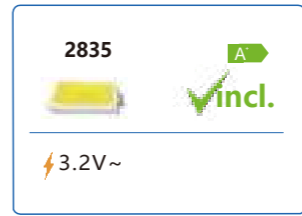
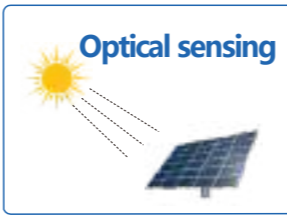

: ZL 2018 3 0571592.1



SOLAR

ACCU

Φ240mm

370mm

Φ120mm

PRODUCT PARAMETERS

Model	BS-GLK37
Solar panels	5V/4.5W
Battery	3.2V/7Ah
Colour temperature	3000/6500K
Charge time	3-5H
Water proof grade	IP65
Material quality	AL+PC
Size	Φ260*H370mm

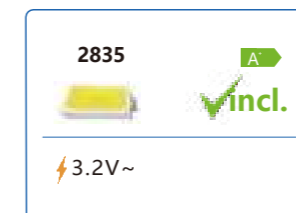
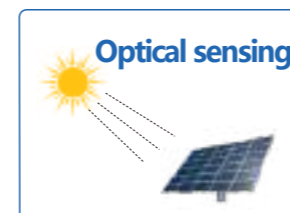

: ZL 2019 3 0009097.6

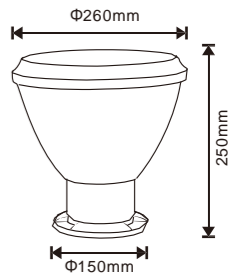

PRODUCT PARAMETERS

Model	BS-GLH25
Solar panels	5V/4.5W
Battery	3.2V/7Ah
Colour temperature	3000/6500K
Charge time	3-5H
Water proof grade	IP65
Material quality	AL+PC
Size	Φ260*H250mm

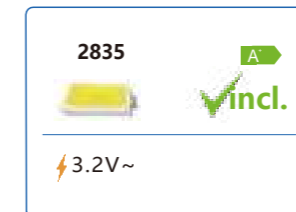
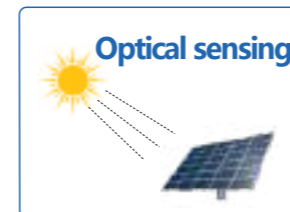

: ZL 2018 3 0284826.4

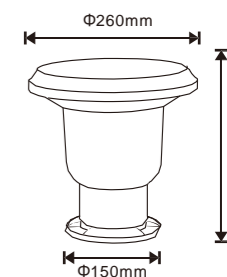

PRODUCT PARAMETERS

Model	BS-GLI25
Solar panels	5V/4.5W
Battery	3.2V/7Ah
Colour temperature	3000/6500K
Charge time	3-5H
Water proof grade	IP65
Material quality	AL+PC
Size	Φ260*H250mm

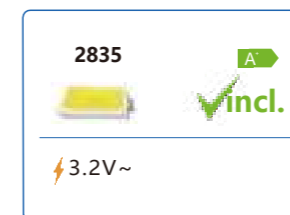
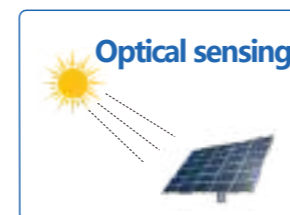

: ZL 2018 3 0516647.9

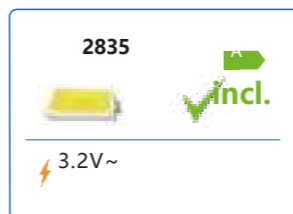
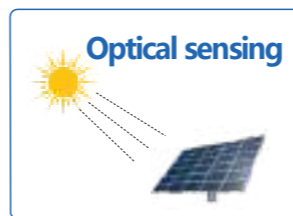
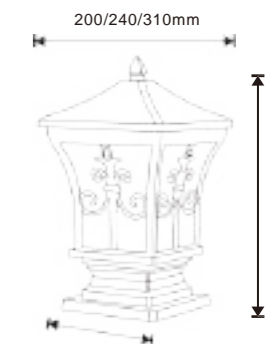

PRODUCT PARAMETERS

Model Solar panels	BS-GLR200	BS-GLR250	BS-GLR300
Battery	5.5V/2W	5.5V/3W	5.5V/4.8W
Colour temperature	3.2V/2.6Ah	3.2V/3.6Ah	3.2V/6.4Ah
	3000/6500K	3000/6500K	3000/6500K
Charge time	3-5H	3-5H	3-5H
Water proof grade	IP65	IP65	IP65
Material quality	AL+PC	AL+PC	AL+PC
Size	150*H370mm	190*H450mm	250*H580mm



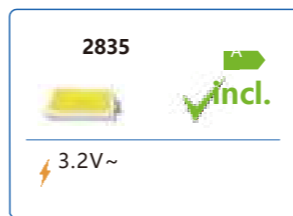
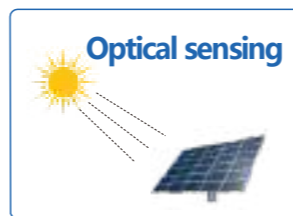
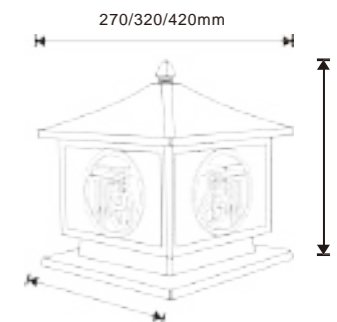

PRODUCT PARAMETERS

Model	Solar panels	BS-ZTD5512-小号	BS-ZTD5512-中号	BS-ZTD5512-大号
Battery	6V/3W	6V/4.8W	6V/7.2W	
Colour temperature	3.2V/3200mAh	3.2V/6400mAh	3.2V/6400mAh	
Charge time	3000-6500K	3000-6500K	3000-6500K	
Water proof grade	3-5H	3-5H	3-5H	
Material quality	IP65	IP65	IP65	
Size	AL+PC	AL+PC	AL+PC	
	250*H330mm	280*H350mm	370*H450mm	



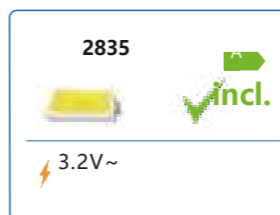
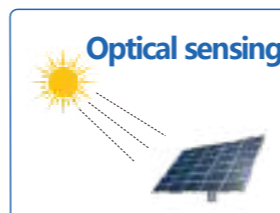
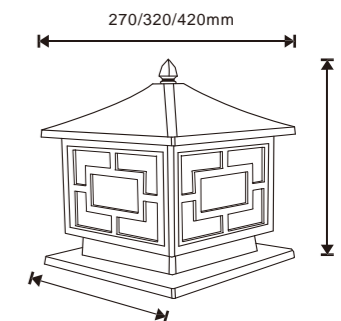

PRODUCT PARAMETERS

Model Solar panels	BS-GLN250	BS-GLN300	BS-GLN400
Battery	6V/3W	6V/4.8W	6V/7.2W
Colour temperature	3.2V/3.6Ah	3.2V/6.4Ah	3.2V/6.4Ah
	3000/6500K	3000/6500K	3000/6500K
Charge time	3-5H	3-5H	3-5H
Water proof grade	IP65	IP65	IP65
Material quality	AL+PC	AL+PC	AL+PC
Size	250*H330mm	280*H360mm	370*H460mm



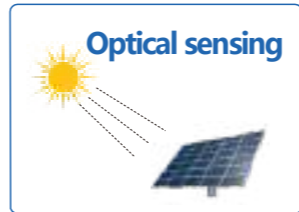
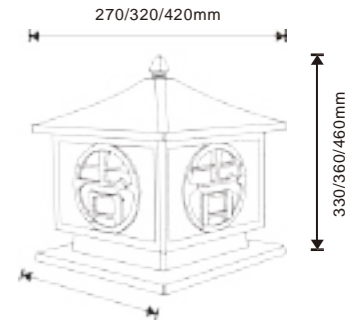

PRODUCT PARAMETERS

Model	Solar panels	BS-ZTD3604-小号	BS-ZTD3604-中号	BS-ZTD3604-大号
Battery	6V/3W	6V/4.8W	6V/7.2W	
Colour temperature	3.2V/3600mAh	3.2V/6400mAh	3.2V/6400mAh	
Charge time	3000-6500K	3000-6500K	3000-6500K	
Water proof grade	3-5H	3-5H	3-5H	
Material quality	IP65	IP65	IP65	
Size	AL+PC	AL+PC	AL+PC	
	250*H330mm	300*H360mm	400*H460mm	



: ZL 2017 3 0437636.7



SOLAR

ACCU

200/240mm

370/450mm

PRODUCT PARAMETERS

Model Solar panels	BS-GLT200	BS-GLT250
Battery	5.5V/2W	5.5V/3W
Colour temperature	3.2V/2600mAh	3.2V/3600mAh
	3000-6500K	3000-6500K
Charge time	3-5H	3-5H
Water proof grade	IP65	IP65
Material quality	+PC	+PC
Size	150*150*H370mm	190*190*H450mm

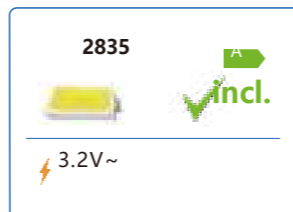
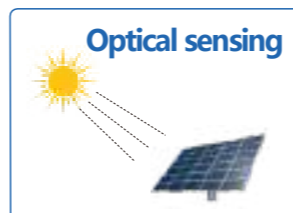



PRODUCT SPECIFICATIONS



SOLAR

ACCU

Optical sensing

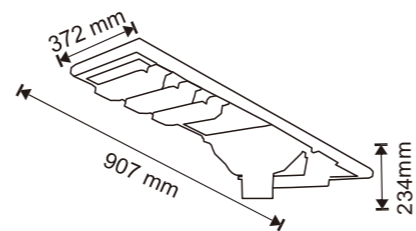

1

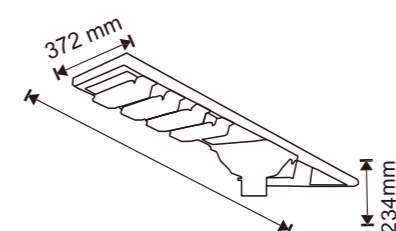

2

213.3mm

2835

incl.

3.2V~

LM-80

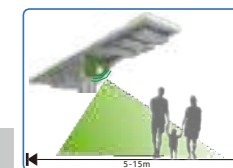

Model	1 BS-STF100	2 BS-STF200	3 BS-STF300
	27V/45W	27V/59W	24V/70W
	19.2V/14.4AH	19.2V/18AH	19.2V/24AH
CCT	W/WW	W/WW	W/WW
	6-8H	6-8H	6-8H
	12-36H	12-36H	12-36H
Material	AL+PC	AL+PC	AL+PC

EMC



PRODUCT SPECIFICATIONS

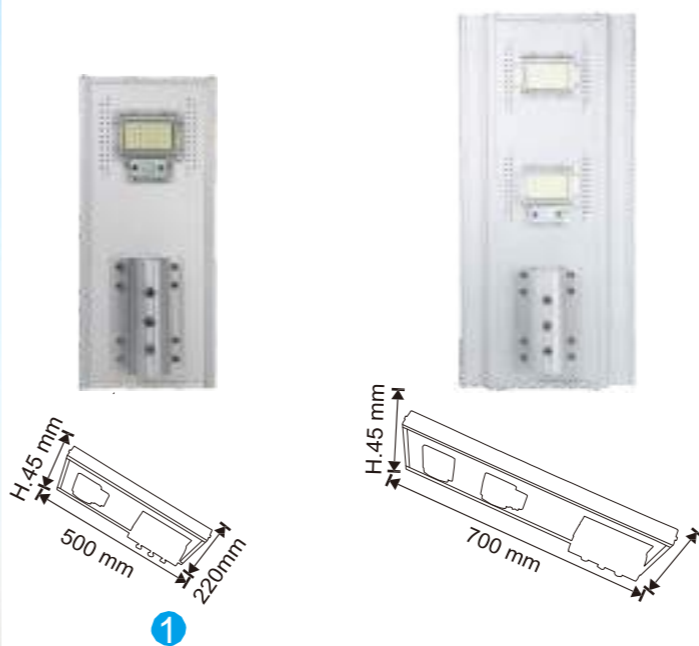

SOLAR

ACCU



Optical sensing

2835

incl.

3.2V~

LM-80

Model	1 BS-STC50	2 BS-STC100	3 BS-STC150	4 BS-STC200	5 BS-STC300
	10V/16W	10V/20W	10V/25W	6V/35W	6V/50W
	6.4V/20AH	6.4V/30AH	6.4V/40AH	3.2V/39AH	3.2V/52AH
CCT	W/WW	W/WW	W/WW	W/WW	W/WW
	6-8H	6-8H	6-8H	3-5H	3-5H
	12-36H	12-36H	12-36H	12-20H	12-20H
Materia	AL	AL	AL	AL	AL

5-15m

EMC



PRODUCT SPECIFICATIONS

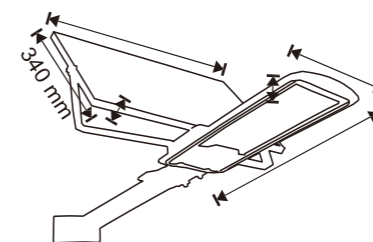
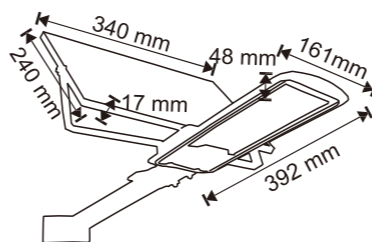

1

SOLAR

ACCU

Optical sensing

2835

incl.

3.2V~

LM-80

Model	1 BS-STH50	2 BS-STH100
	6V/12W	6V/22W
	3.2V/6.5AH	3.2V/18AH
CCT	W/WW	W/WW
	6-8H	6-8H
	12-36H	12-36H
Material	AL	AL





EMC

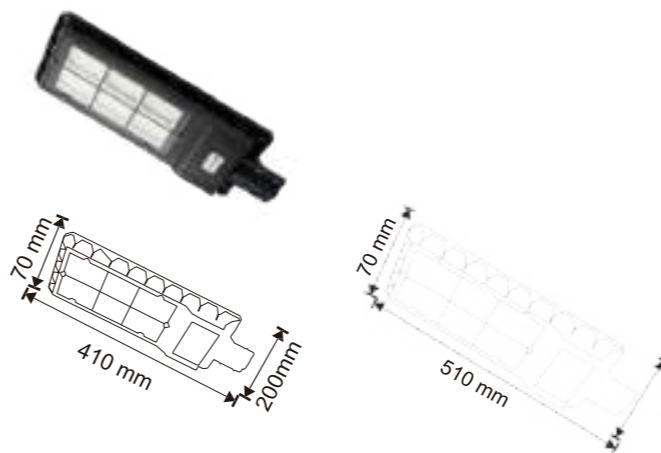

PRODUCT SPECIFICATIONS



①

Model	① BS-STB60	BS-STB120	BS-STB180
 Power	6V/12W	6V/20W	6V/30W
 Battery	3.2V/10AH	3.2V/15AH	3.2V/20AH
CCT	W/WW	W/WW	W/WW
 Lifespan	6-8H	6-8H	6-8H
 Illumination	12-36H	12-36H	12-36H
Material材质	AL	AL	AL

SOLAR

ACCU

Optical sensing

2835

incl.

3.2V~

LM-80

5-15m

EMC



PRODUCT SPECIFICATIONS

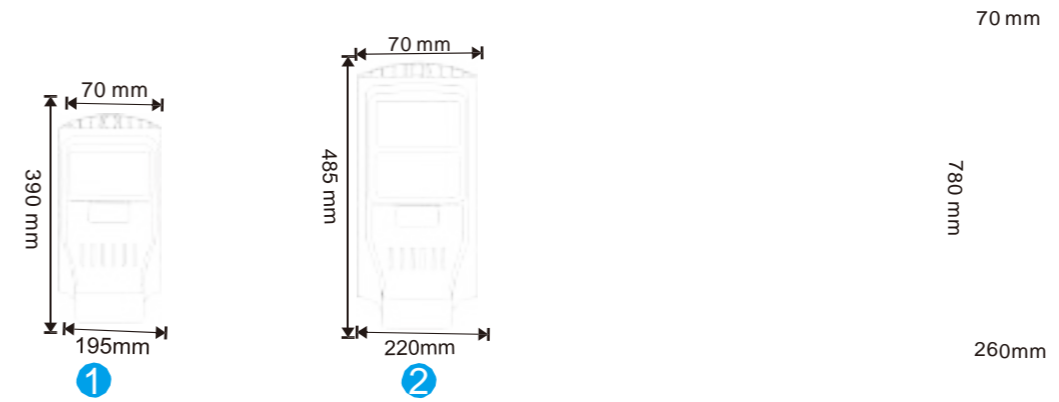

SOLAR

ACCU





Optical sensing

2835

incl.

3.2V~

LM-80

Model	1 BS-STA30	2 BS-STA60	3 BS-STA90	4 BS-STA120
	6V/7W	6V/9W	6V/15W	6V/20W
	3.2V/5AH	3.2V/10AH	3.2V/15AH	3.2V/20AH
CCT	W/WW	W/WW	W/WW	W/WW
	6-8H	6-8H	6-8H	6-8H
	12-36H	12-36H	12-36H	12-36H
Material	ABS	ABS	ABS	ABS

5-15m

EMC



PRODUCT SPECIFICATIONS

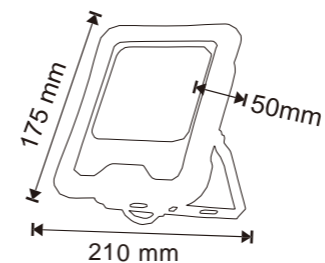

1

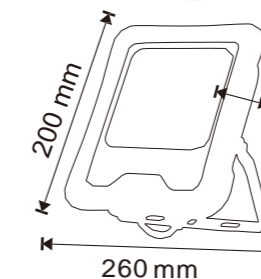

310 mm

SOLAR

ACCU

Optical sensing

2835

incl.

3.2V~

LM-80

Model	1 BS-FLBL50	2 BS-FLBL100	3 BS-FLBL200	4 BS-FLBL300	5 BS-FLBL400	6 BS-FLBL500
	6V/6W	6V/15W	6V/20W	6V/30W	6V/40W	6V/50W
	3.2V/5AH	3.2V/15AH	3.2V/20AH	3.2V/30AH	3.2V/40AH	3.2V/50AH
CCT	W/WW	W/WW	W/WW	W/WW	W/WW	W/WW
	6-8H	6-8H	6-8H	6-8H	6-8H	6-8H
	12-36H	12-36H	12-36H	12-36H	12-36H	12-36H
Materia	AL	AL	AL	AL	AL	AL



PRODUCT SPECIFICATIONS



SOLAR

ACCU

Optical sensing

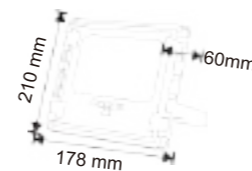

1



4

2835

incl.

3.2V~

LM-80

Model	BS-FLA25	BS-FLA40	BS-FLA60	BS-FLA100	BS-FLA200	BS-FLA300
	6V/14W	6V/18W	6V/22W	6V/35W	6V/48W	6V/55W
	3.2V/6.5AH	3.2V/13AH	3.2V/19.5AH	3.2V/27AH	3.2V/32.5AH	3.2V/39AH
CCT	W/WW	W/WW	W/WW	W/WW	W/WW	W/WW
	6-8H 12-36H	6-8H 12-36H	6-8H 12-36H	6-8H 12-36H	6-8H 12-36H	6-8H 12-36H
Material	AL	AL	AL	AL	AL	AL

EMC



New

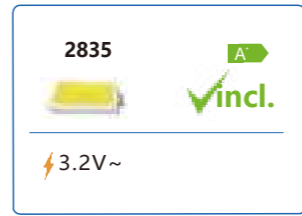
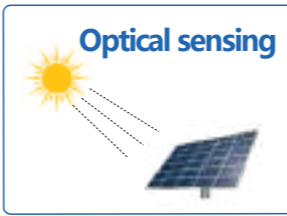

PRODUCT PARAMETERS

Model	BS-XDD2010
Solar panels	6V/10W
Battery	3.2V/9600mAh
Colour temperature	6500K
Charge time	3-5H
Water proof grade	IP65
Material quality Size	PVC+PC
	Φ280mm



Electrical Connection



BS-GGD2005



BS-GGD003



BS-GGD1104



BS-CPD5004



BS-CPD3004



BS-CPD2106



BS-CPD4104



BS-GGD001



BS-GGD002



BS-GGD4205



BS-CPD2204



BS-CPD2104



BS-CPD5405



BS-CPD1004



BS-GGD5405



BS-GGD4105

Electrical Connection



BS-ZTD2104



BS-ZTD2106



BS-ZTD5405



BS-ZTD1004



BS-ZTD4104



BS-ZTD2204



BS-ZTD4205



BS-BD6001



BS-BD3001



BS-BD2106-1



BS-BD2106-2



BS-BD4001



BS-BD1104



BS-BD4005



BS-BD1004



BS-BD2104